

TEMPLATE ASSEMBLY KEY PLAN

rcFoamFighters

FF-JUPITER

(Design by Paul Petty - Aug. 2009 - Rev 1.0 BETA)

(CAD Drawing by Paul Petty - Aug. 2009)

INSTRUCTIONS:
PRINT ALL TEMPLATE SHEETS. CUT AND ASSEMBLE AS SHOWN
BELOW. USE SCOTCH TAPE TO SECURE SHEETS TOGETHER.

**BETA SET, BASIC PARTS
TEMPLATE ONLY!!**

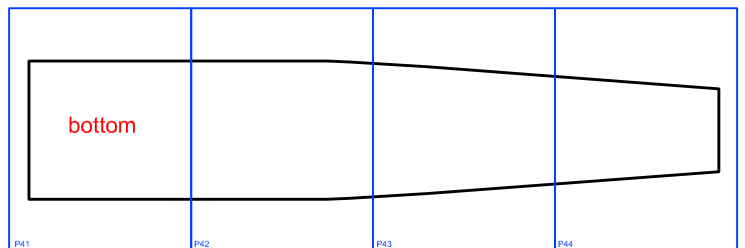
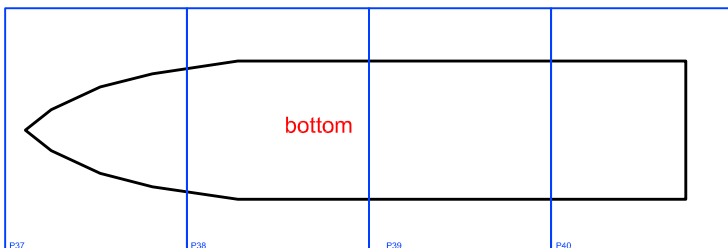
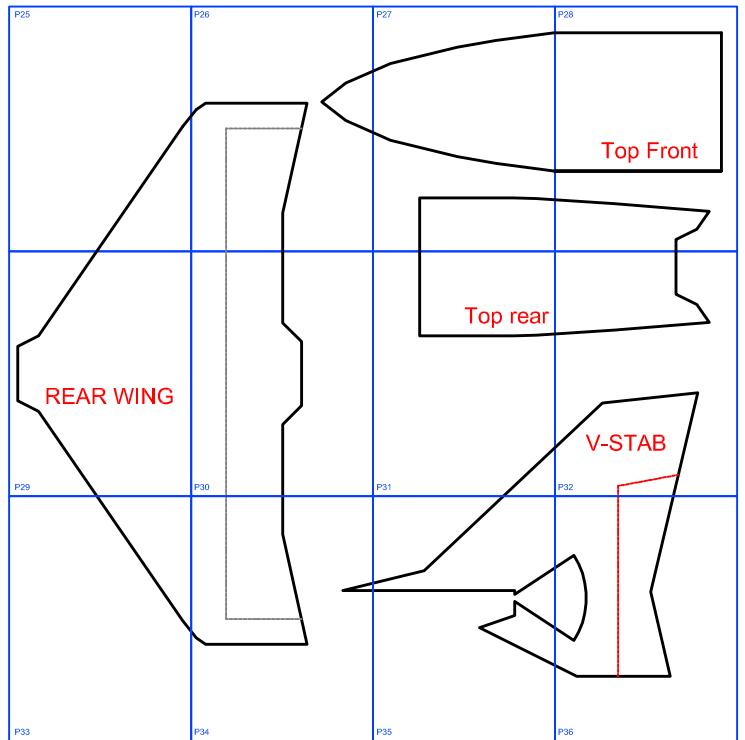
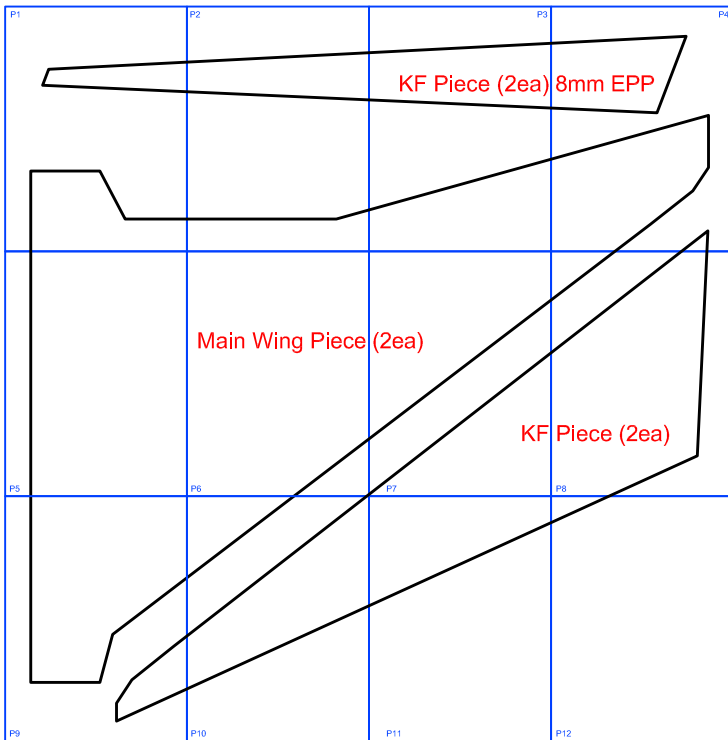
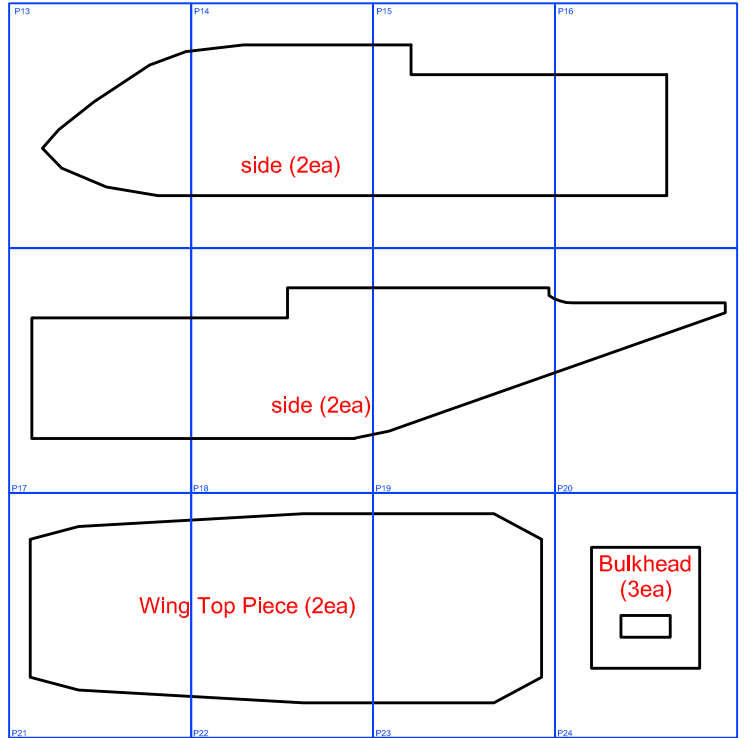

EPP FOAM SHEETS REQUIRED

4EA 36"X24" 15mm EPP FOAM SHEETS

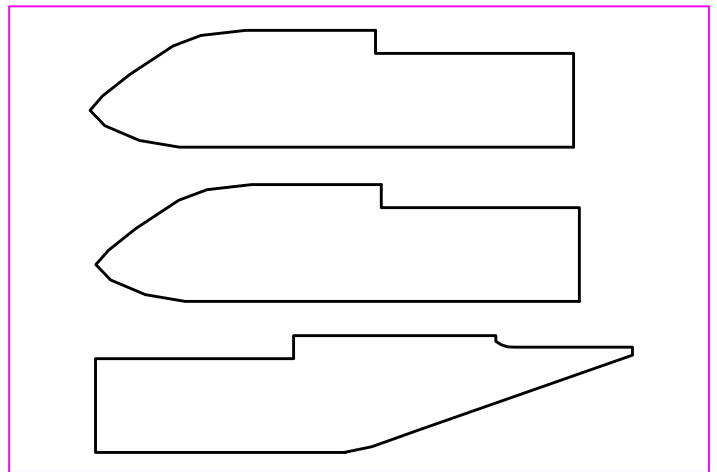
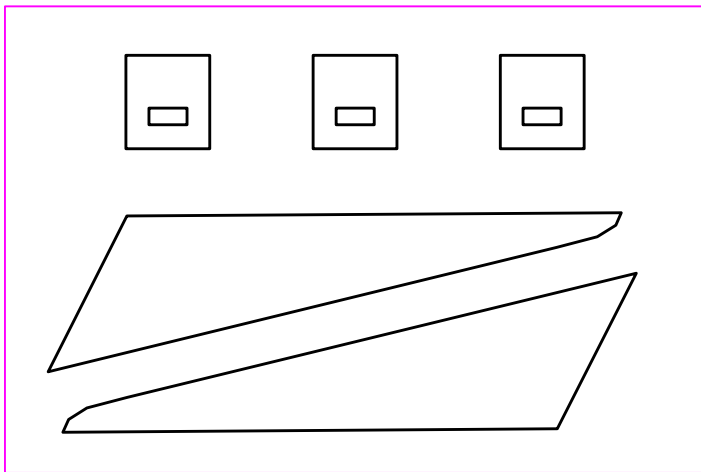
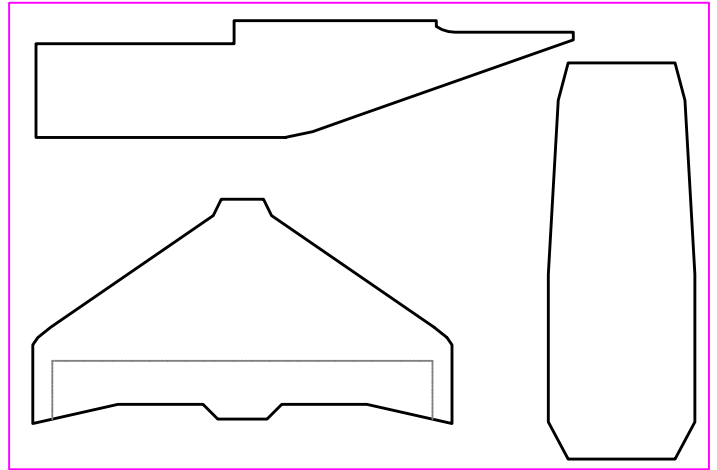
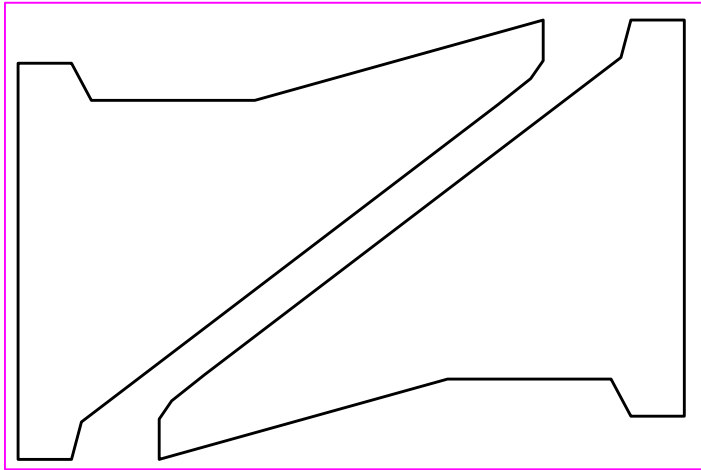

1EA 36"X24" 8mm EPP FOAM SHEETS

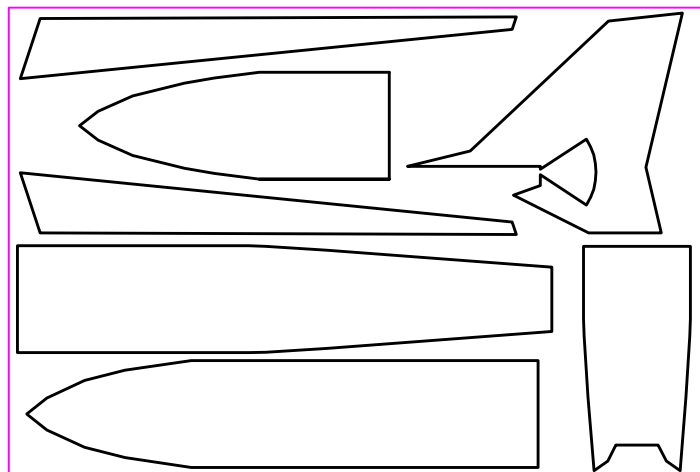

P1

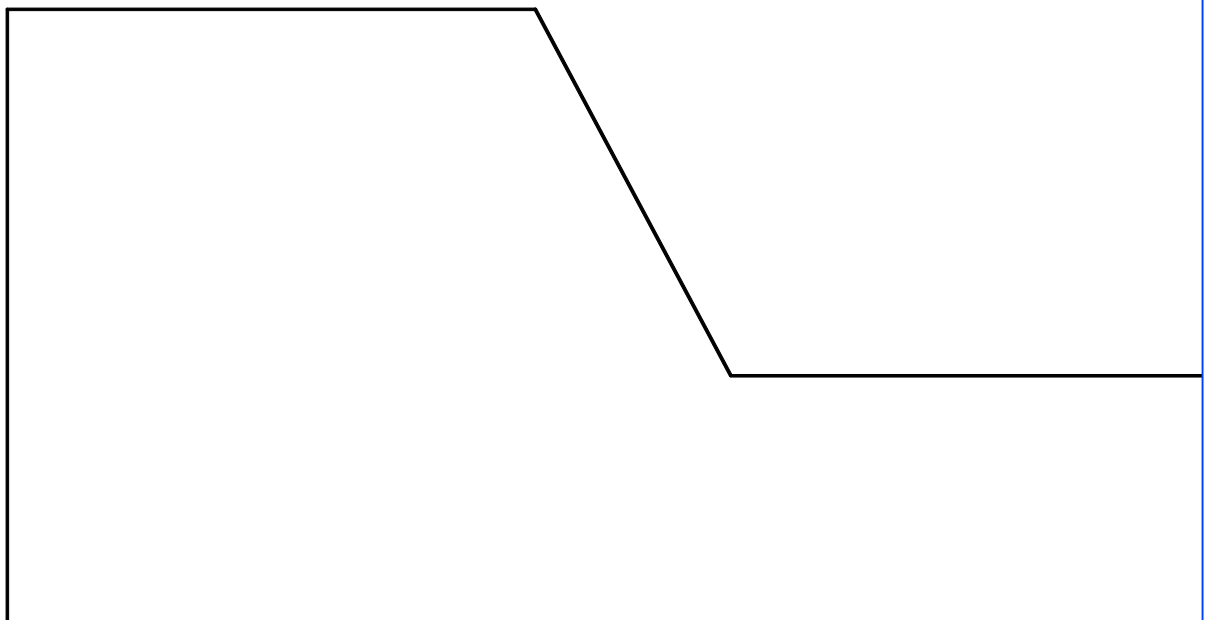
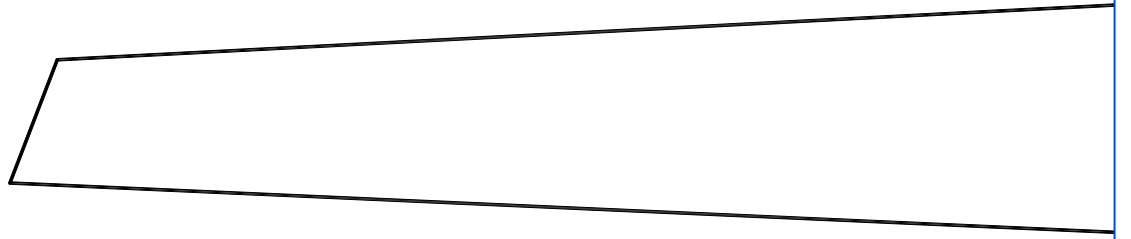

P2

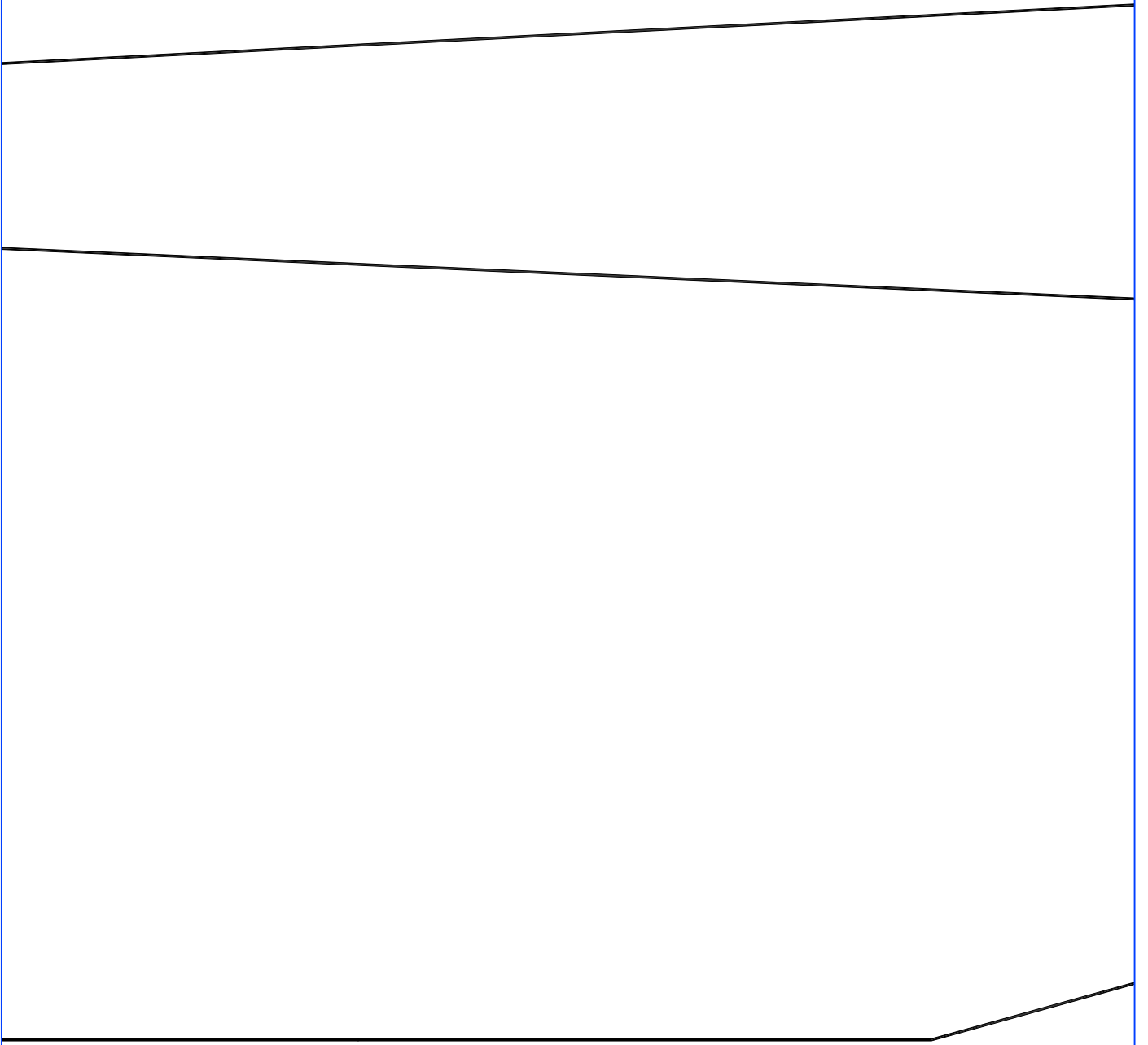

KF Piece (2ea)

8mm EPP

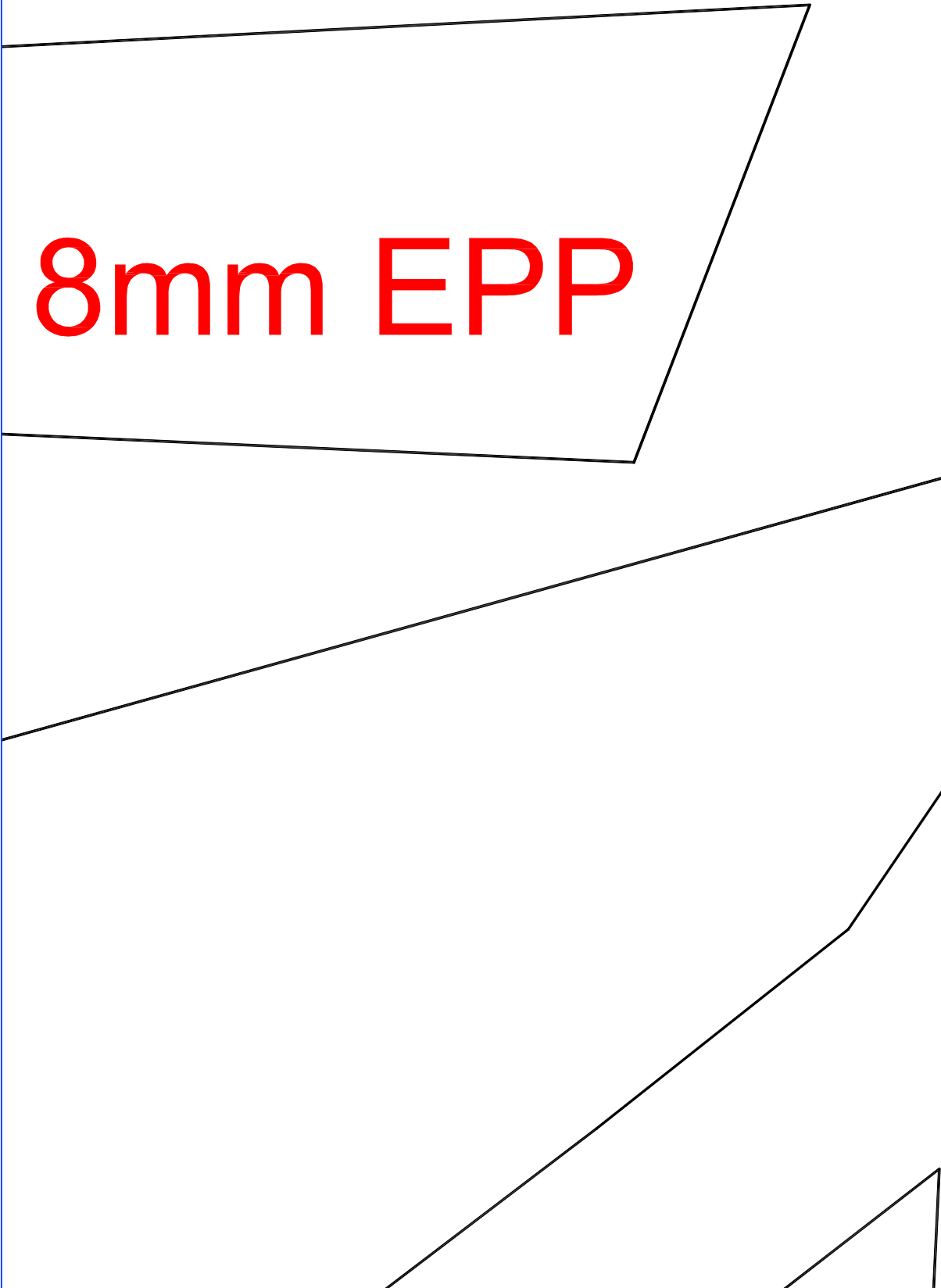

Main Wing Piece

(2ea)

KF

P7



Piece (2ea)

P8

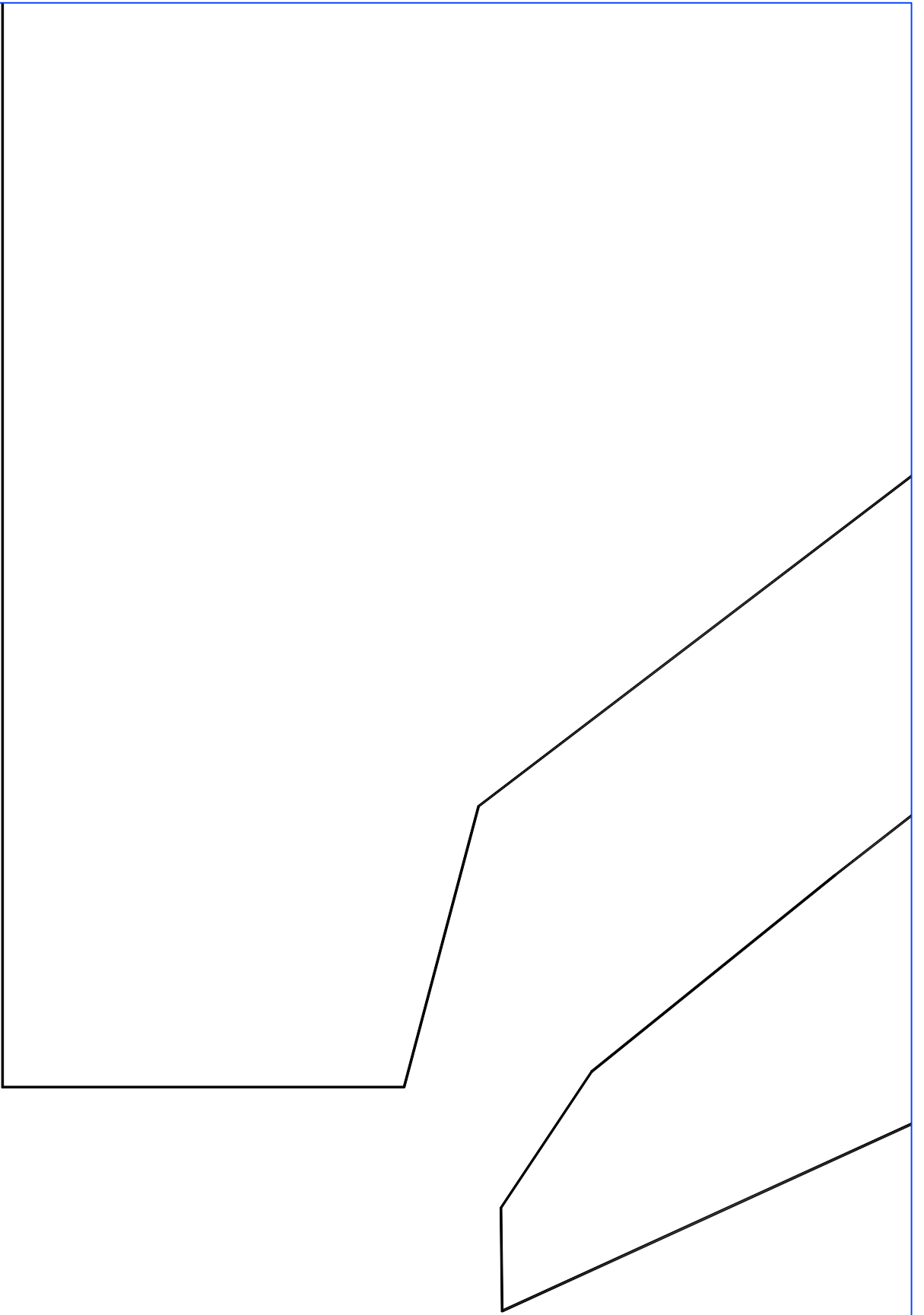

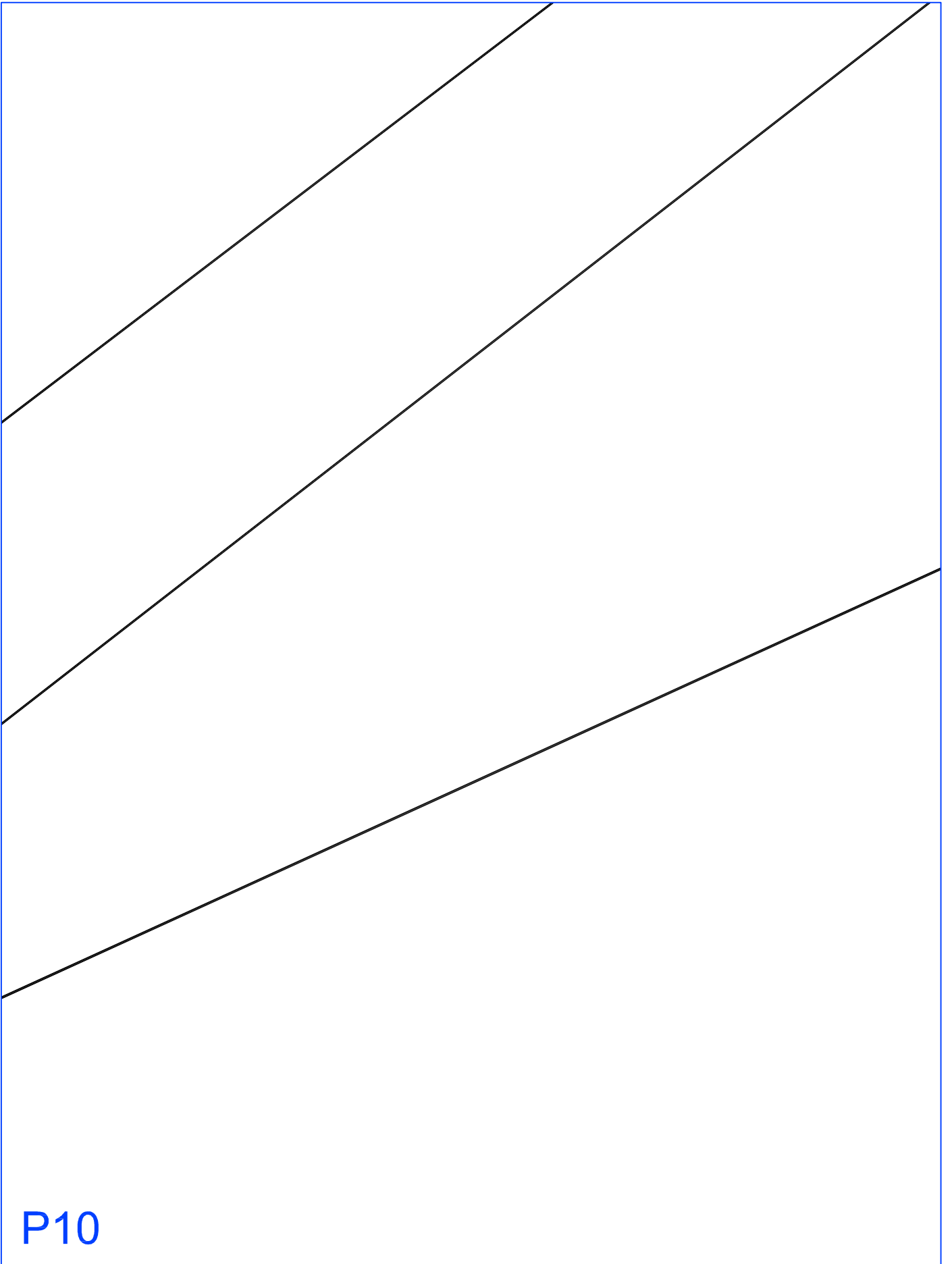

P10

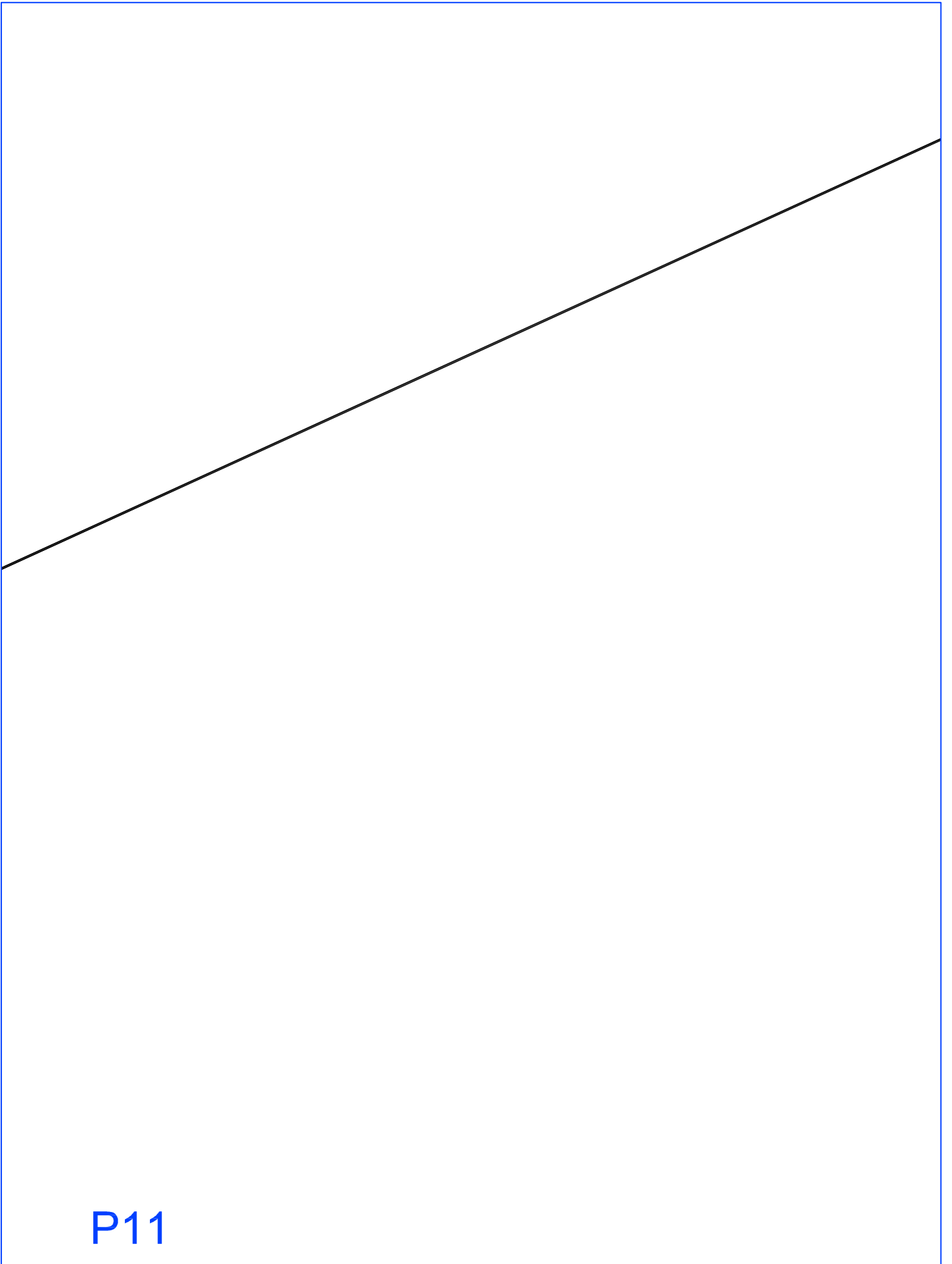

P11

P13

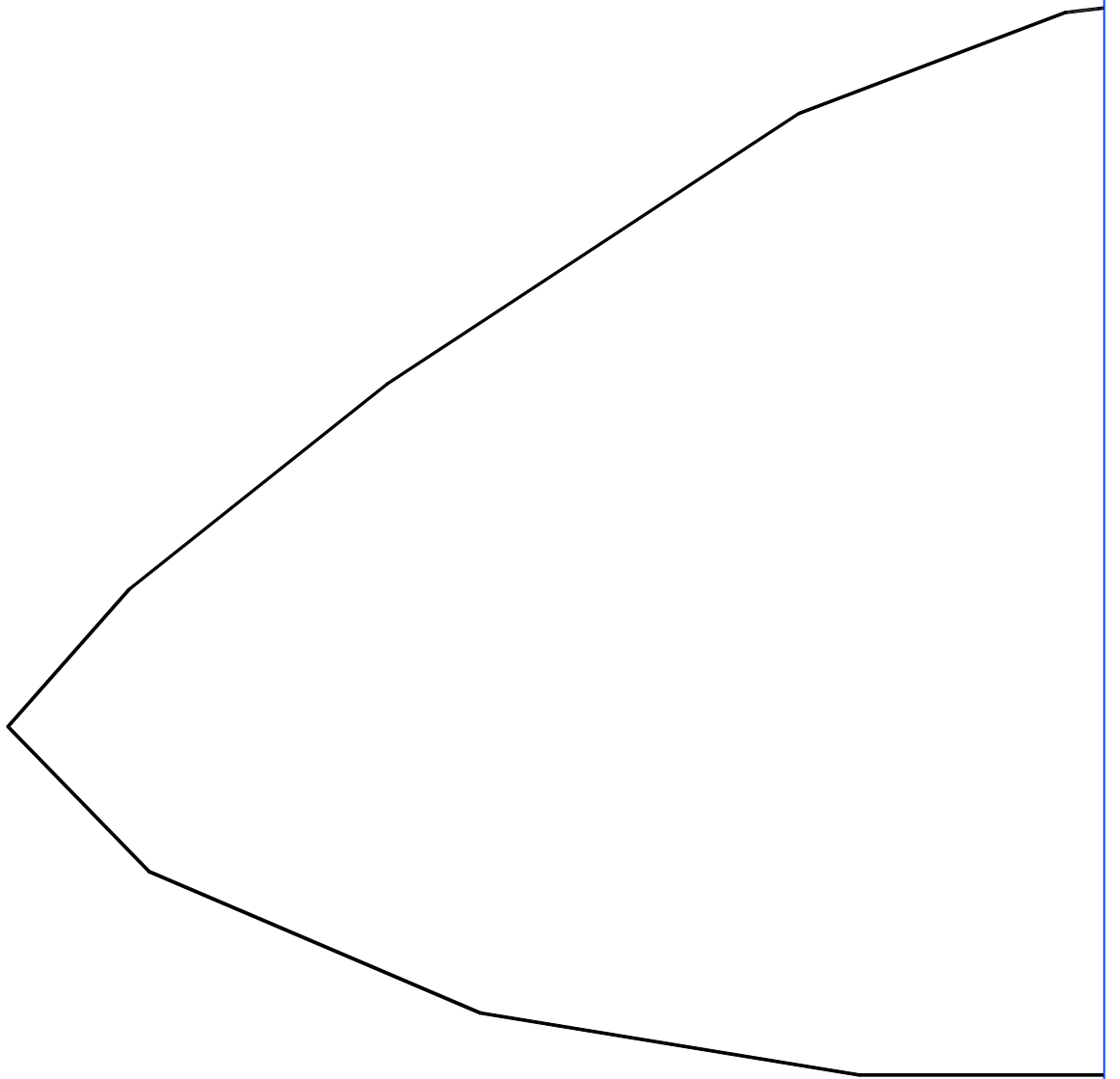

P14

side (2ea)

P15

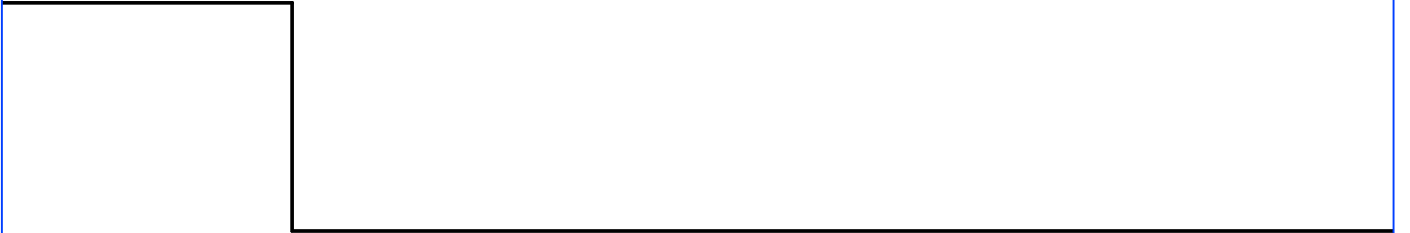

P16

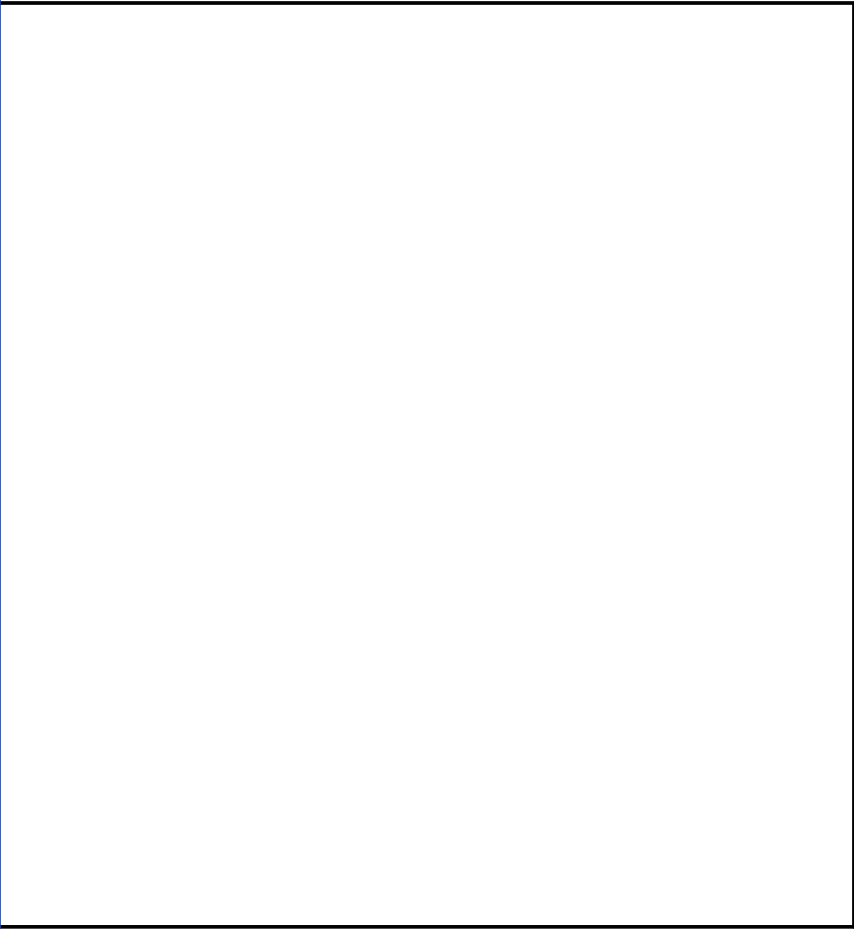

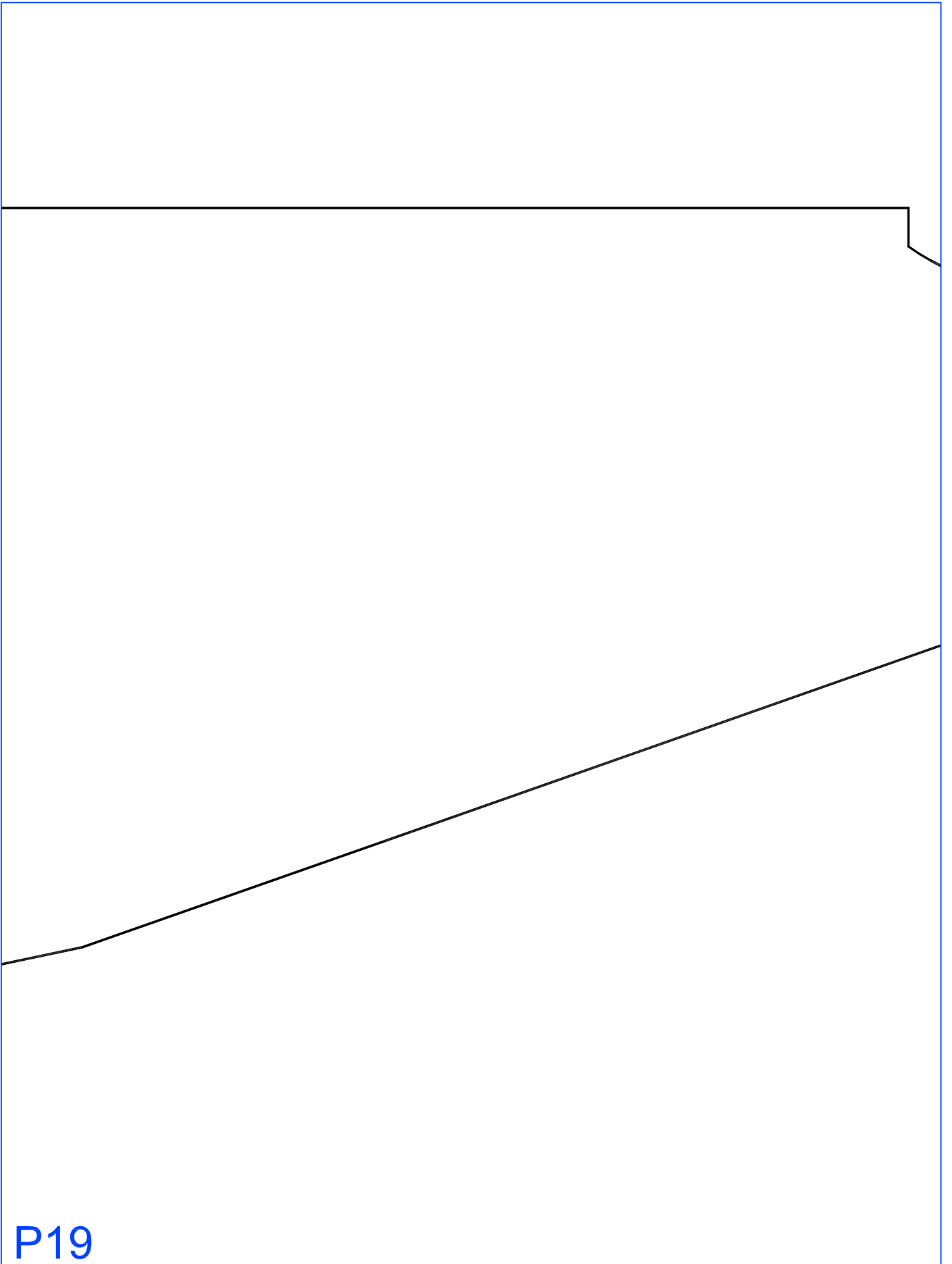

P19

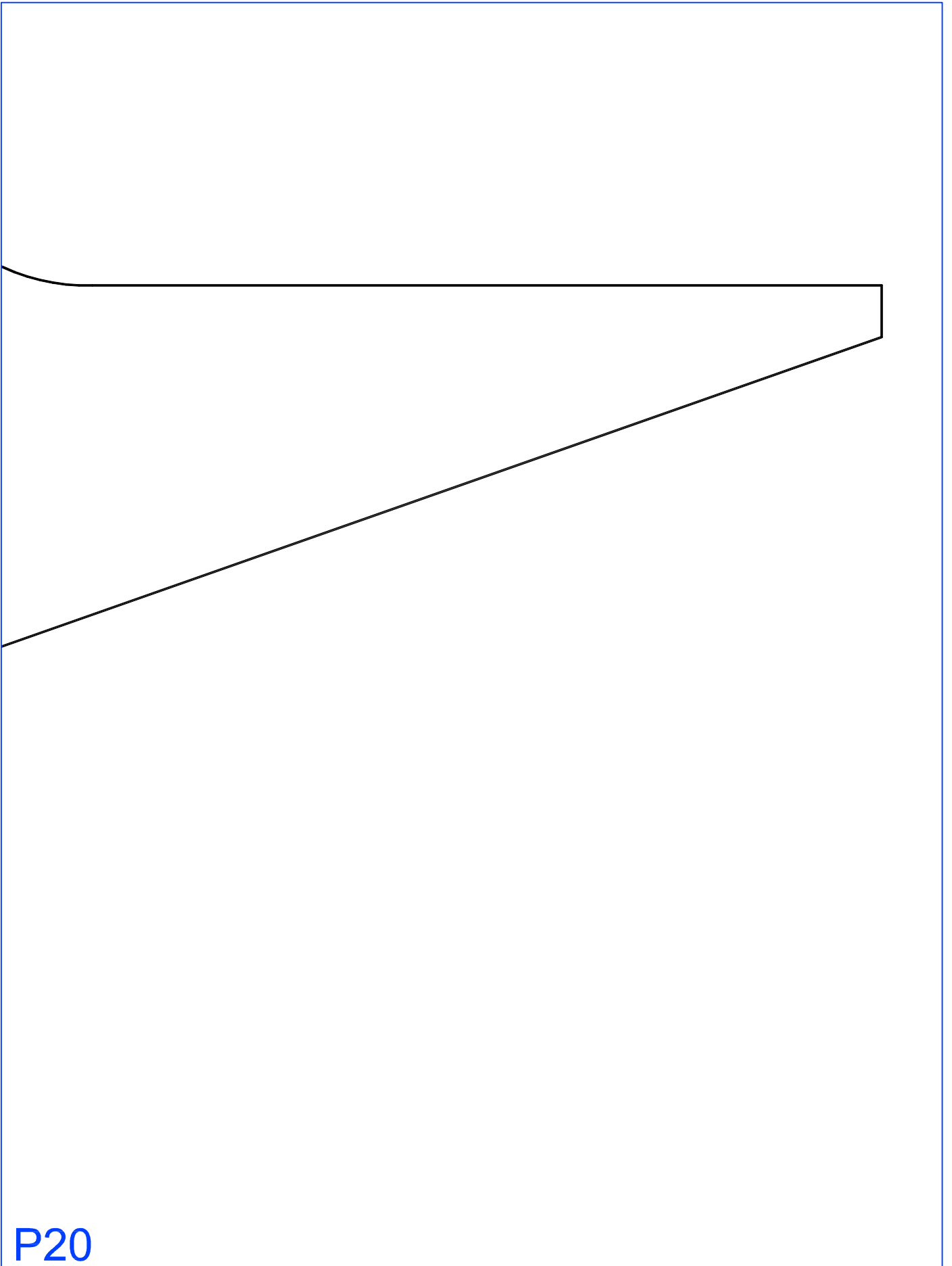



Wing

Top Piece (2ea)

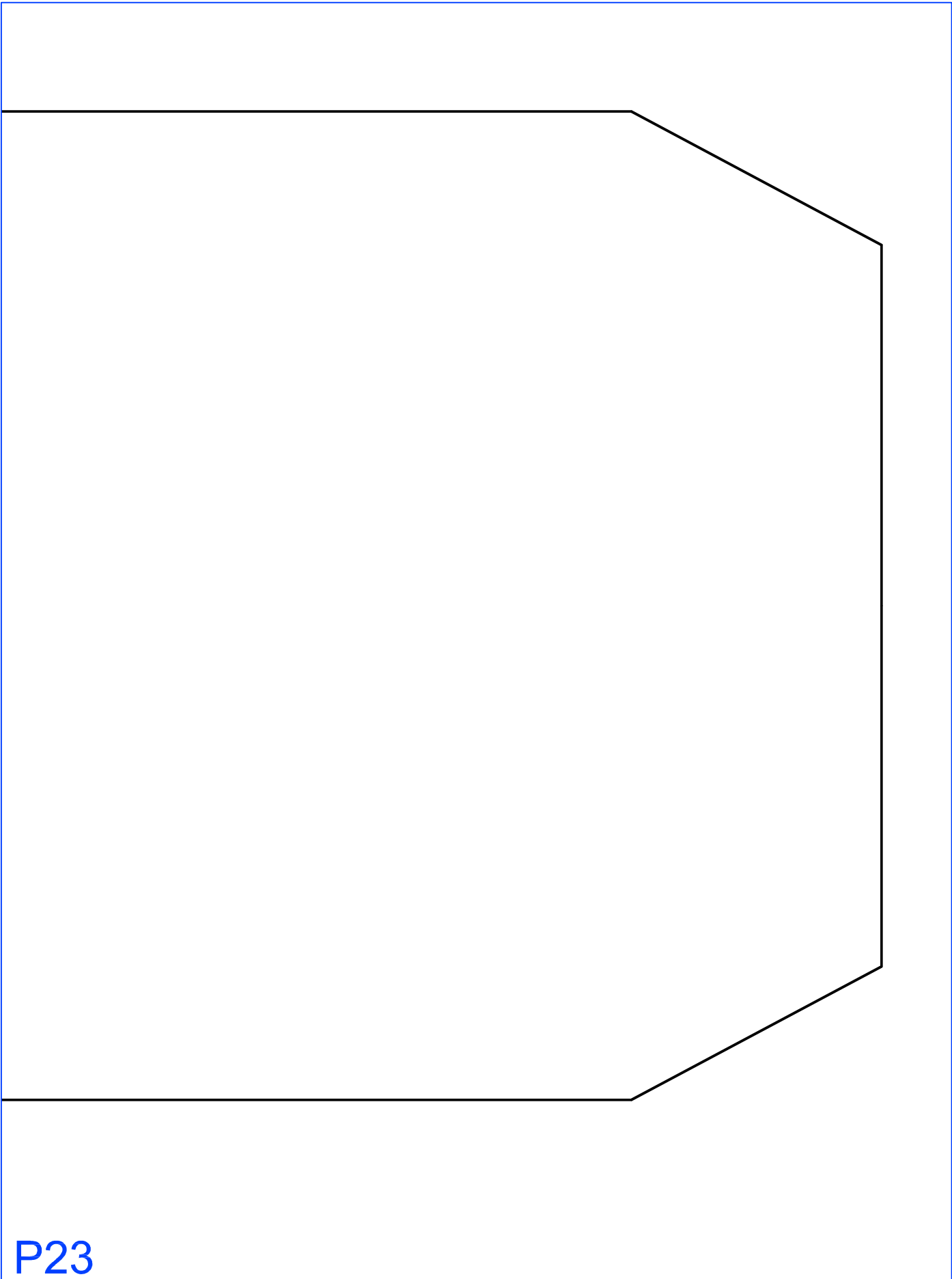

Bulkhead (3ea)

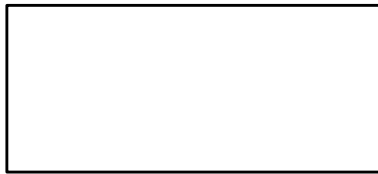

P25

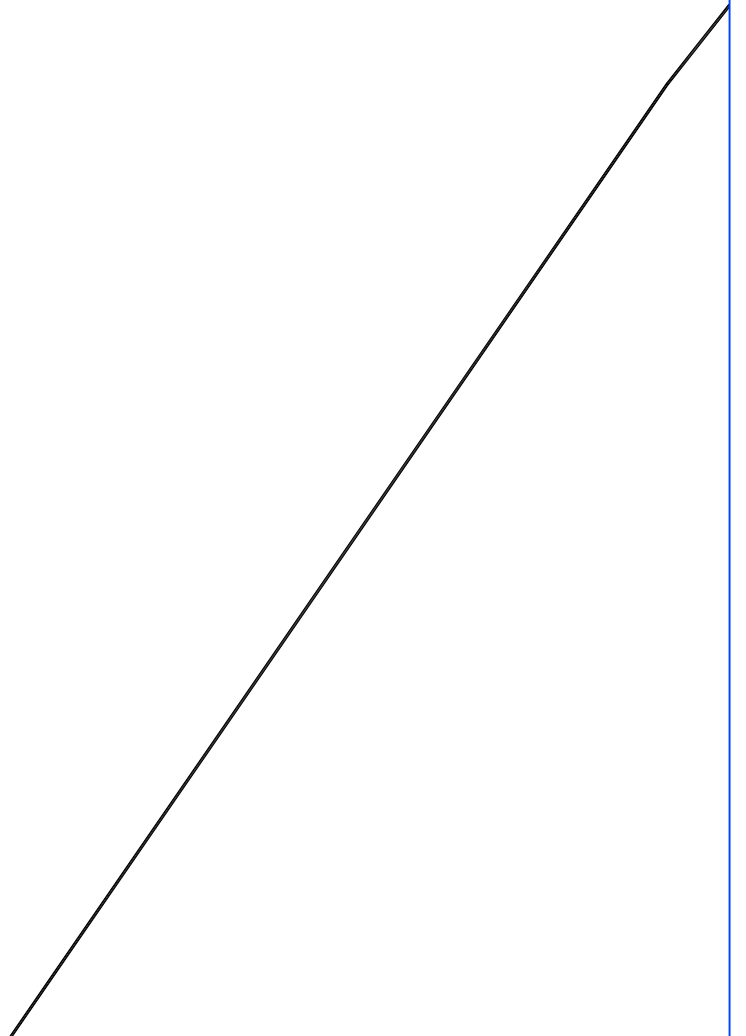

P26

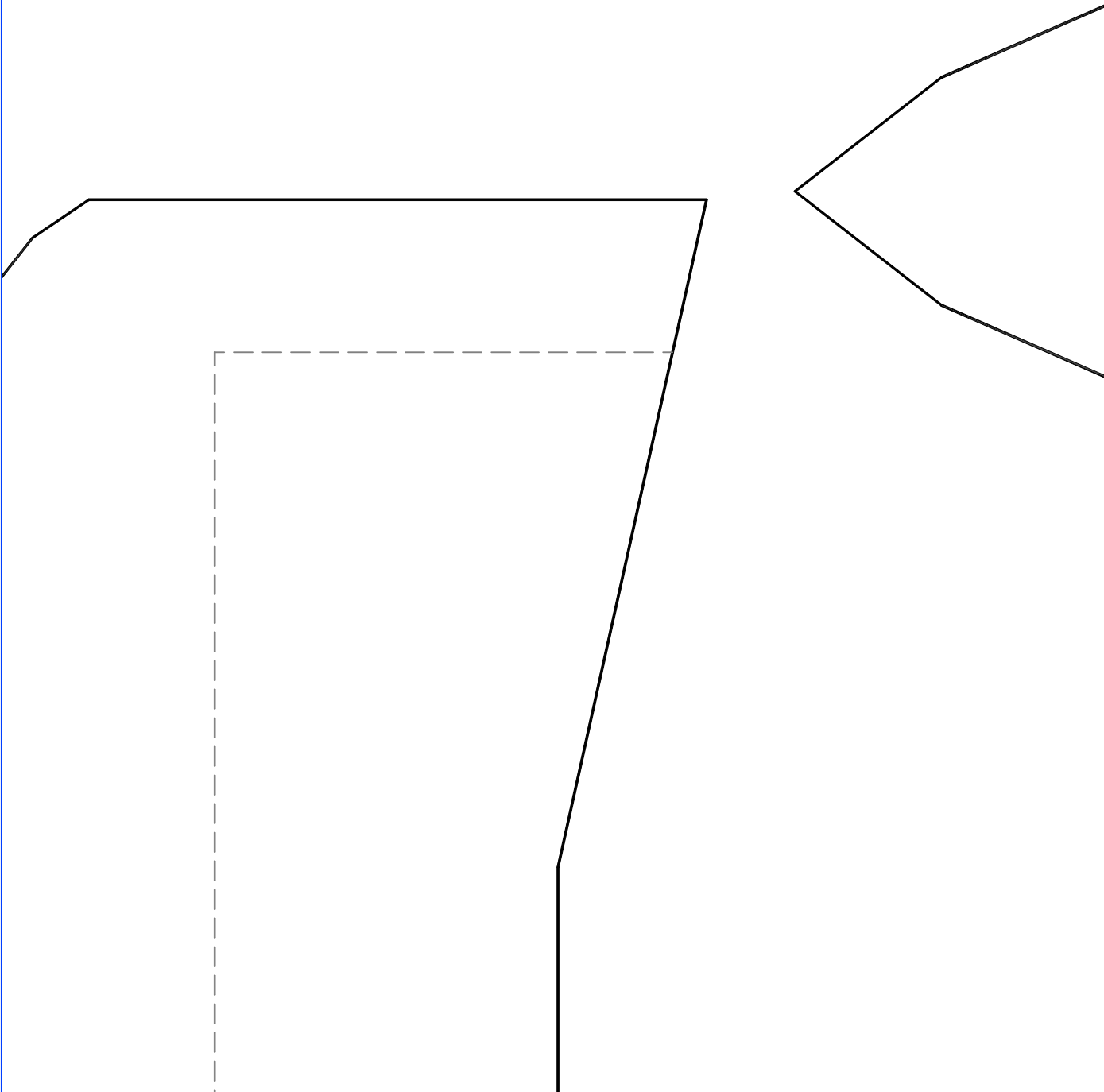

P27

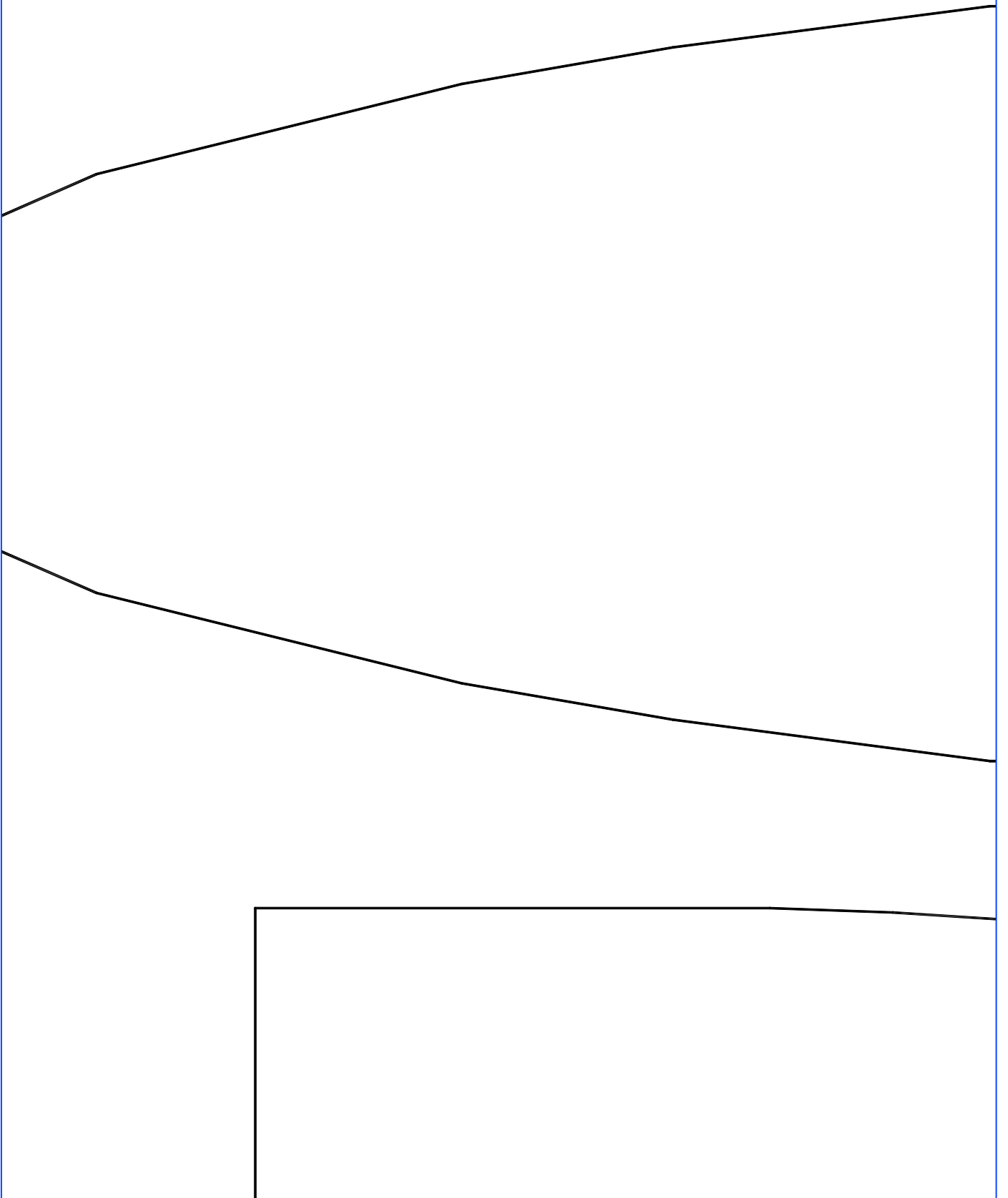

Top Front

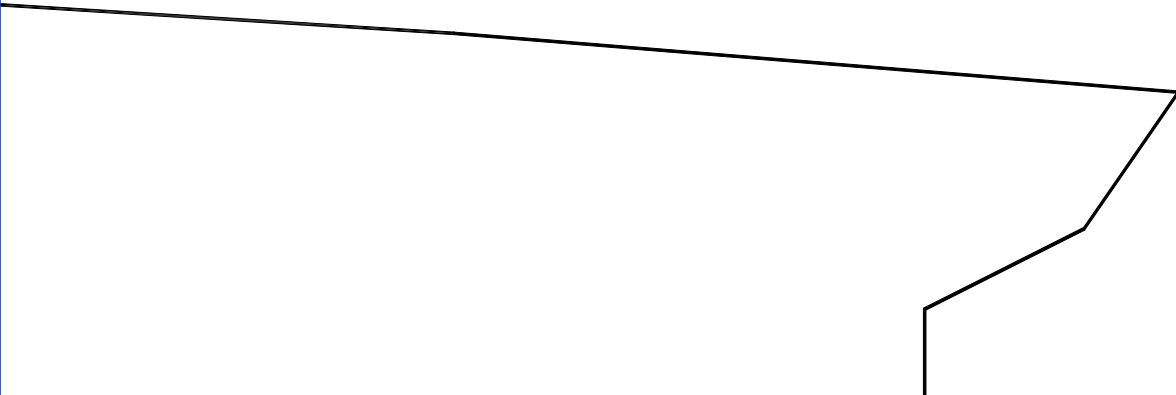



REAR WING

P29

P30

Top rear



V-STAB

P32

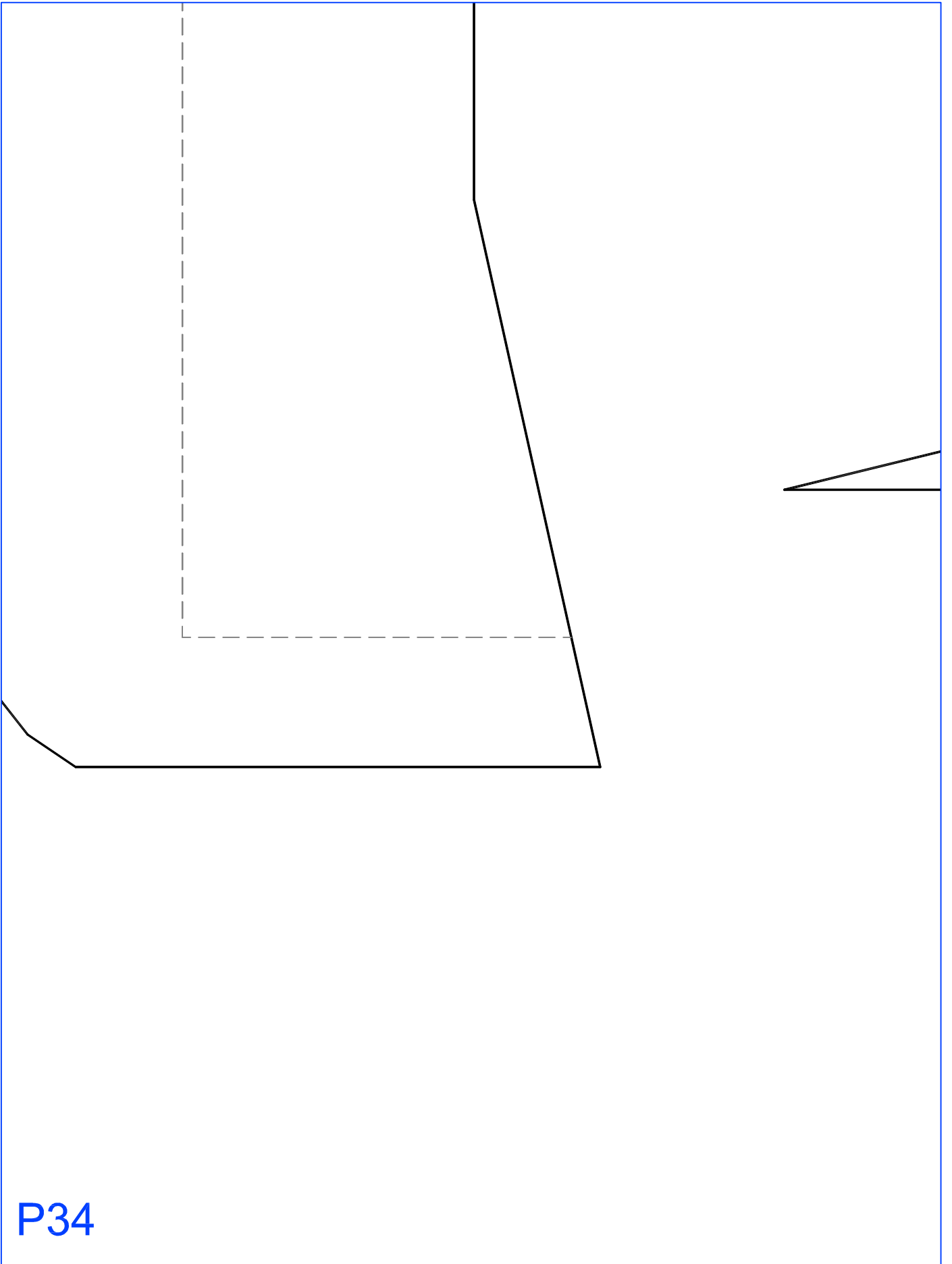

P34

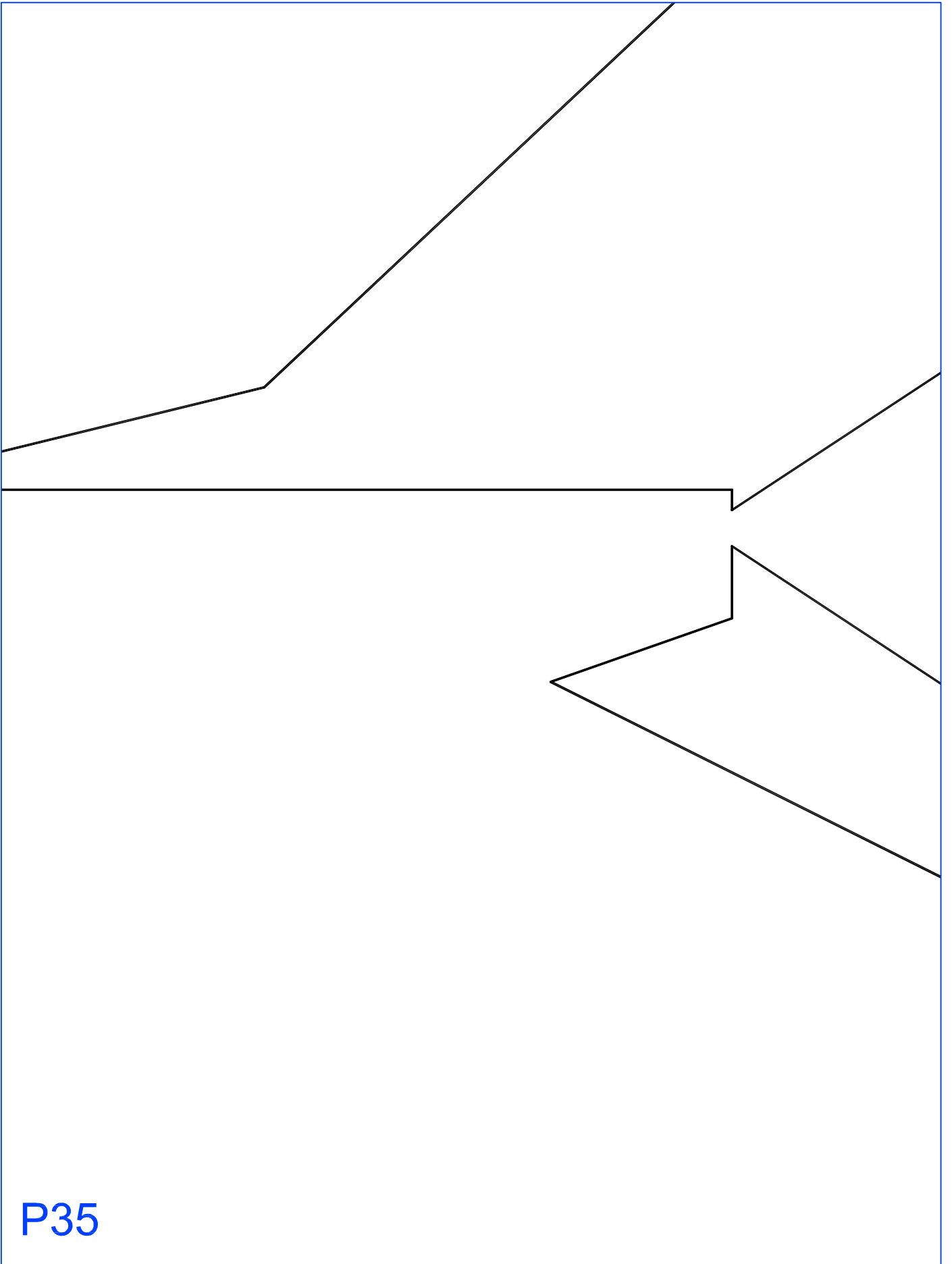

P35

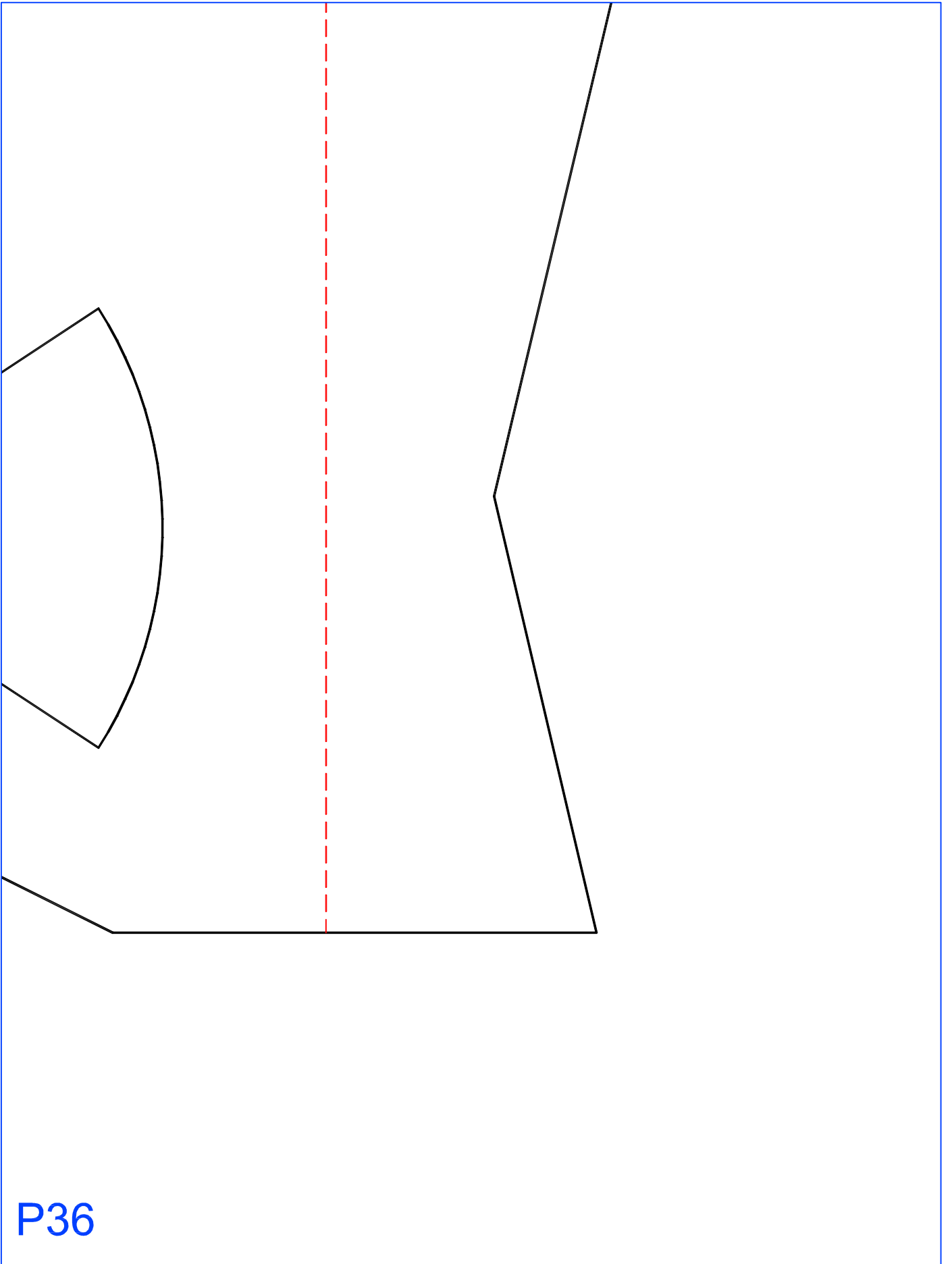

P36

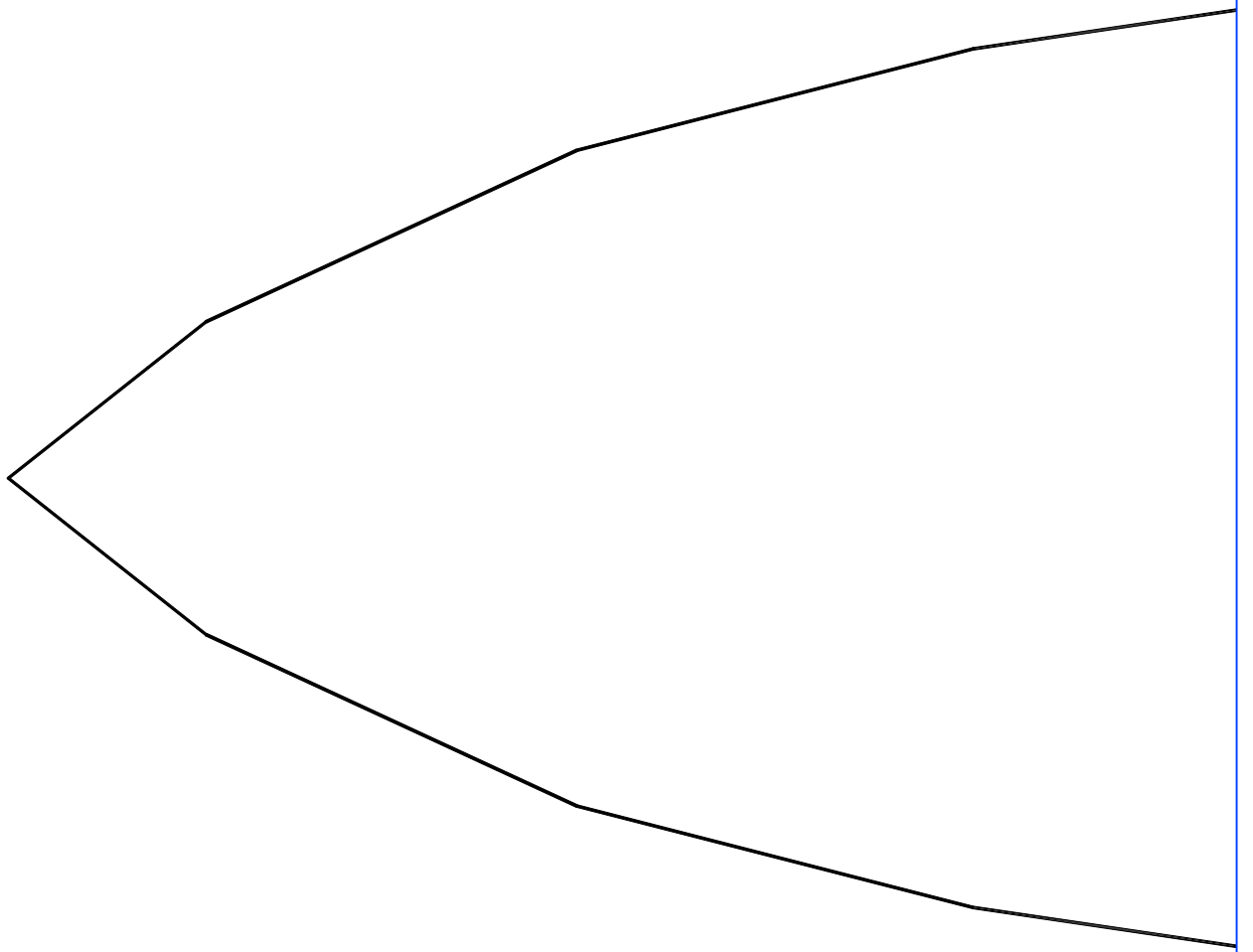



bottom

bottom

